

# Commercial lights & Household lights

**YUSING**

[www.yusinglighting.com](http://www.yusinglighting.com)

# Office Downlights

  
**100-10%**  
**IP65**



**CE**  **CB**



Milky white mask, soft light, not dazzling

Ultra-thin lamp body, shallow design

PC material, safe and reliable

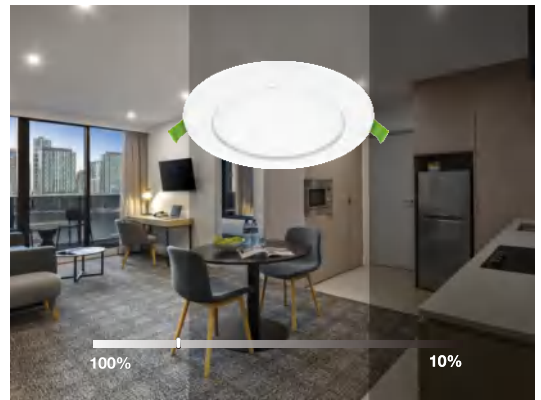





**SMD2835**



**120°**



**ECO**

Item No.	Voltage [V]	Wattage [W]	Function	Lumen [lm]	Ra	PF	Material	Lifetime [H]	Size [D*Hmm]	Ceiling Hole [mm]
AL1016-6W	220-240	6	/	480	>80	>0.9	PC	30000	Ø115*27	Ø100-110
AL1016-10W	220-240	10	/	800	>80	>0.9	PC	30000	Ø170*27	Ø150-160
AL1016-16W	220-240	16	/	1280	>80	>0.9	PC	30000	Ø220*27	Ø200-210
AL1016-22W	220-240	22		1760	>80	>0.9	PC	30000	Ø240*39	Ø220-230
AL1016-7W-T	220-240	7		560	>80	>0.9	PC	30000	Ø115*27	Ø100-110
AL1016-13W-T	220-240	13		1040	>80	>0.9	PC	30000	Ø170*27	Ø150-160
AL1016-17W-T	220-240	17		1280	>80	>0.9	PC	30000	Ø220*27	Ø200-210
AL1016-23W-T	220-240	23		1840	>80	>0.9	PC	30000	Ø240*39	Ø220-230

# Office Downlights



Color Temp.  
adjustable



## Dialup dimming



## Products

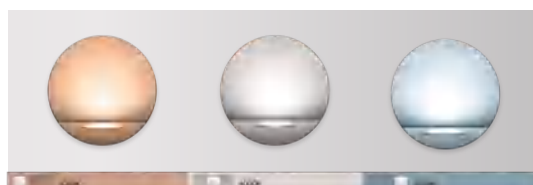

3000K                      4000K                      6500K

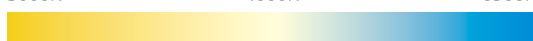

## Installation

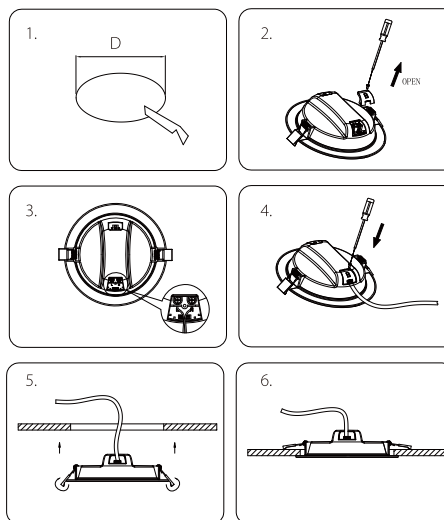

SMD2835



120°



ECO

Item No.	Voltage [V]	Wattage [W]	Lumen [lm]	Ra	PF	Material	Lifetime [H]	Size [D*Hmm]	Ceiling Hole [mm]	Packing [Pcs / M <sup>3</sup> / KG]
AL2006-9	185-265	9	585	≥80	>0.5	PA+PS	30000	Ø115*45	Ø100	40 / 0.0438 / 6.6
AL2006-15	185-265	15	1200	≥80	>0.5	PA+PS	30000	Ø165*45	Ø150	30 / 0.0635 / 8.5
AL2006-20	185-265	20	1600	≥80	>0.5	PA+PS	30000	Ø220*45	Ø200	20 / 0.0726 / 9.1
AL2006-24	185-265	24	1920	≥80	>0.5	PA+PS	30000	Ø245*45	Ø225	20 / 0.088 / 10.4



## Adjustable Opening Hole

Details



Side



Cut-out size adjustable

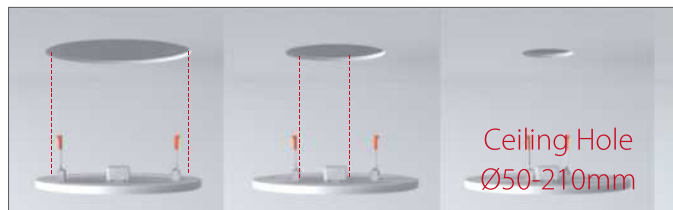





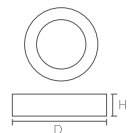

Item No.	Voltage [V]	Wattage [W]	Lumen [lm]	Ra	PF	Material	Lifetime [H]	Size [L*W*Hmm]	Ceiling Hole [mm]	Packing [Pcs / M <sup>2</sup> / KG]
AL1055-6	100-240	6	300	≥70	>0.5	PC	30000	Ø100*20	Ø50-90	100 / 0.049 / 10.8
AL1055-8	100-240	8	400	≥70	>0.5	PC	30000	Ø115*20	Ø50-100	100 / 0.049 / 13.2
AL1055-15	100-240	15	870	≥70	>0.5	PC	30000	Ø175*20	Ø50-160	20 / 0.66 / 25
AL1055-18	100-240	18	1200	≥70	>0.5	PC	30000	Ø230*20	Ø50-210	20 / 0.072 / 23

# Office Downlights



Color Temp.  
adjustable



Dimmable



## Details

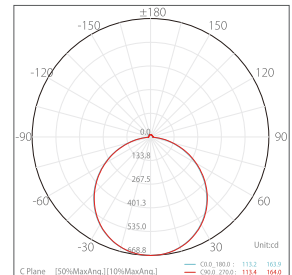
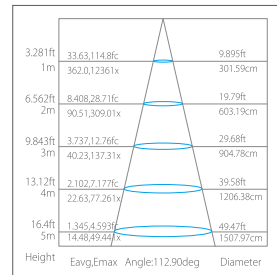
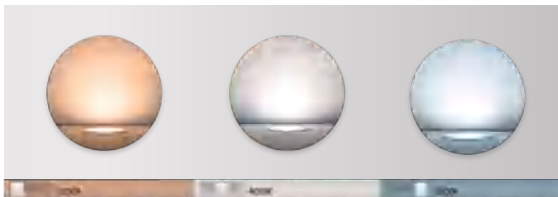

SMD2835



110°



ECO

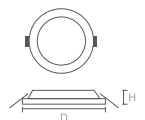

Item No.	Voltage [V]	Wattage [W]	Lumen [lm]	Ra	PF	Material	Lifetime [H]	Size [L*W*Hmm]	Ceiling Hole [mm]	Packing [Pcs / M <sup>3</sup> / KG]
AL2005	220-240	9	800	≥80	>0.9	PA	30000	Ø110*60	Ø92	20 / 0.044 / 6.7

# Office Downlights



Color Temp.  
adjustable



Dimmable

**100 LM/W**



CE



RoHS

IC-4



Dialup dimming

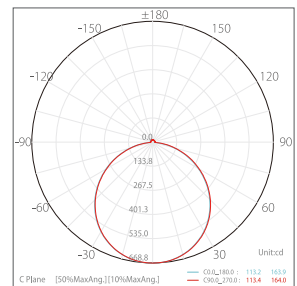
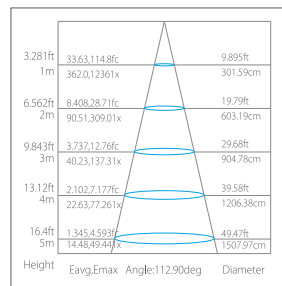
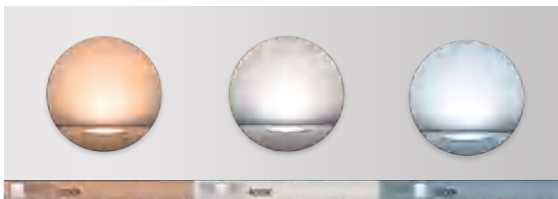

SMD2835



120°



ECO

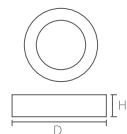

Item No.	Voltage [V]	Wattage [W]	Lumen [lm]	Ra	PF	Material	Lifetime [H]	Size [L*W*Hmm]	Ceiling Hole [mm]	Packing [Pcs / M <sup>3</sup> / KG]
AL2016-7	220-240	7	700	≥80	>0.9	PP	30000	∅105*48	∅85	36 / 0.05 / 9



# Office Downlights



Color Temp.  
adjustable



Dimmable



Dialup dimming

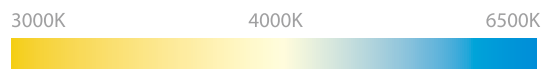
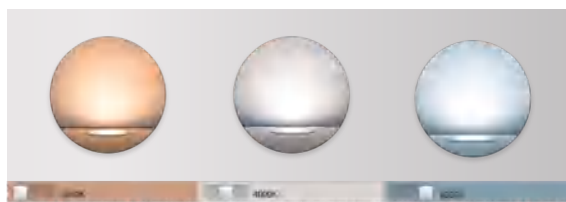

Installation

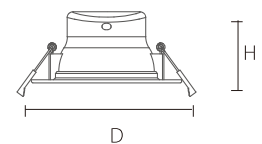
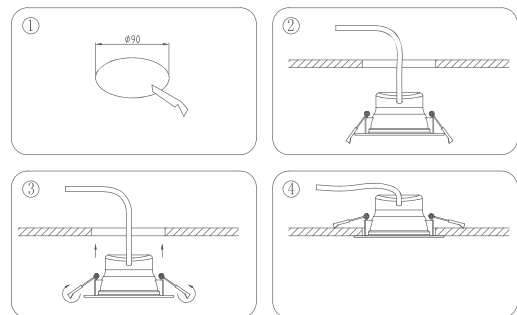

Item No.	Voltage [V]	Wattage [W]	Lumen [lm]	Ra	PF	Material	Lifetime [H]	Size [L*W*Hmm]	Ceiling Hole [mm]	Packing [Pcs / M <sup>2</sup> / KG]
AL5006	220-240	8	700	≥80	>0.9	PBT+Alu.+PS	40000	Ø110*52	Ø 90	20 / 0.025 / 5.1

# Office Downlights



## Details

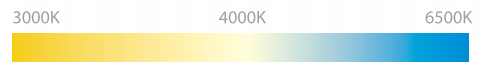
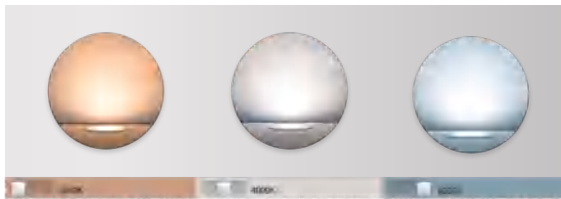

## Installation

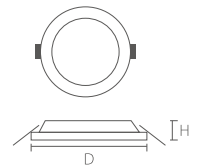
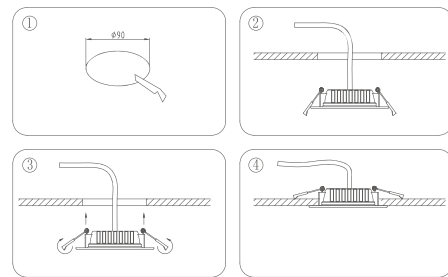





Item No.	Voltage [V]	Wattage [W]	Lumen [lm]	Ra	PF	Material	Lifetime [H]	Size [L*W*Hmm]	Ceiling Hole [mm]	Packing [Pcs / M <sup>2</sup> / KG]
AL5007-10	220-240	10	800	≥80	>0.9	PA	30000	Ø110*40	Ø90	30 / 0.07 / 7.5
AL5007-12	220-240	12	960	≥80	>0.9	PA	30000	Ø110*40	Ø90	30 / 0.07 / 7.5



# Ceiling Lights



- Multi scene selection
- Smart control

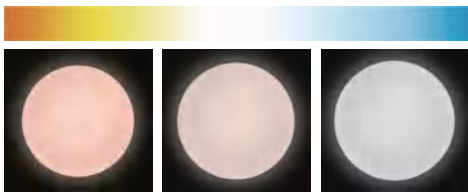

Item No.	Voltage [V]	Wattage [W]	Lumen [lm]	Ra	PF	Life time [H]	Material	Size [DxHmm]	Packing [Pcs / M³ / KG]
Smart-CE2017	185-265	12	840	≥80	>0.9	25000	PMMA+IRON	Ø260 * 60	20/0.013/10
Smart-CE2017	185-265	18	1260	≥80	>0.9	25000	PMMA+IRON	Ø330 * 65	20/0.022/12
Smart-CE2017	185-265	24	1680	≥80	>0.9	25000	PMMA+IRON	Ø380 * 65	20/0.032/14
Smart-CE2017	185-265	36	2500	≥80	>0.9	25000	PMMA+IRON	Ø380 * 65	/
Smart-CE2017	185-265	48	3100	≥80	>0.9	25000	PMMA+IRON	Ø480 * 75	/
Smart-CE2017	185-265	60	3900	≥80	>0.9	25000	PMMA+IRON	Ø600 * 100	/
Smart-CE2017	185-265	80	4800	≥80	>0.9	25000	PMMA+IRON	Ø700 * 120	/
Smart-CE2017	185-265	100	6000	≥80	>0.9	25000	PMMA+IRON	Ø800 * 140	/

# Ceiling Lights



85lm/w

CCT

DIM

IP65



- Easy Installation
- 60mm Ultra-thin
- High Luminous Efficiency

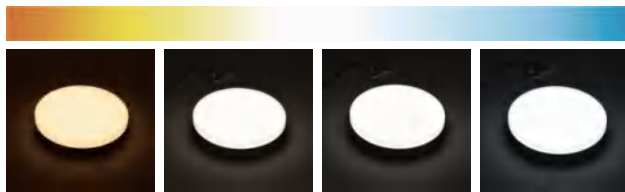

CE RoHS EMC ERP2.0

Item No.	Voltage [V]	Wattage [W]	Lumen [lm]	Ra	PF	Life time [H]	Material	Size [DxHmm]	Packing [Pcs / M <sup>3</sup> / KG]
CE2179C-DP-G1	185-265	12	1020	80	>0.5	25000	PC+PC	Ø280 * 60	10/0.056/12
CE2179C-DP-G1	185-265	15	1275	80	>0.5	25000	PC+PC	Ø280 * 60	10/0.056/12
CE2179C-DP-G1	185-265	18	1530	80	>0.5	25000	PC+PC	Ø280 * 60	10/0.056/12
CE2179C-DP-G1	185-265	24	2040	80	>0.5	25000	PC+PC	Ø280 * 60	10/0.056/12

# Ceiling Lights

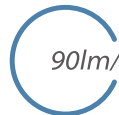

CE2003C

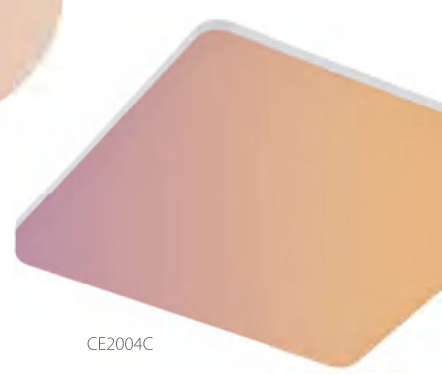

CE2004C

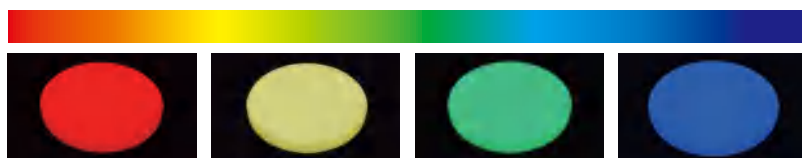

Item No.	Voltage [V]	Wattage [W]	Lumen [lm]	Ra	PF	Life time [H]	Material	Size [LxWxHmm]	Packing [Pcs / M <sup>2</sup> / KG]
CE2003C	220-240V	15	1350	≥80	>0.5	25000	PC+PC	Ø220*50	10/0.035/7.5
CE2003C	220-240V	18	1620	≥80	>0.5	25000	PC+PC	Ø280*50	10/0.055/8.5
CE2003C	220-240V	24	2160	≥80	>0.5	25000	PC+PC	Ø330*50	10/0.074/9.5
CE2003C	220-240V	36	3240	≥80	>0.9	25000	PC+PC	Ø330*50	10/0.074/9.5
CE2004C	220-240V	15	1350	≥80	>0.5	25000	PC+PC	220*220*50	10/0.035/7.5
CE2004C	220-240V	18	1620	≥80	>0.5	25000	PC+PC	280*280*50	10/0.055/8.5
CE2004C	220-240V	24	2160	≥80	>0.5	25000	PC+PC	330*330*50	10/0.074/9.5
CE2004C	220-240V	36	3240	≥80	>0.5	25000	PC+PC	330*330*50	10/0.074/9.5

# Ceiling Lights

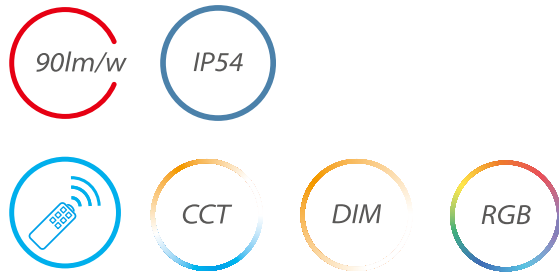

- Easy Installation
- Back glow
- 62mm Ultra-thin
- High Luminous Efficiency

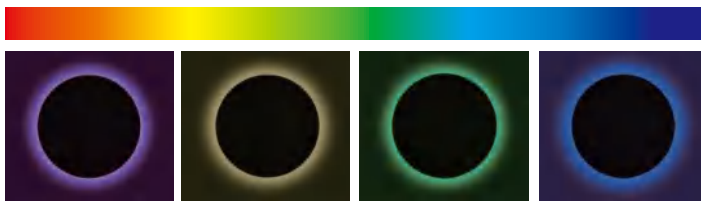
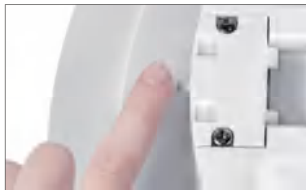

Item No.	Voltage [V]	Wattage [W]	Lumen [lm]	Ra	PF	Life time [H]	Material	Size [DxHmm]	Packing [Pcs / M <sup>3</sup> / KG]
CE2003BC-24W2-IR3-G1	180-240	24	2160	80	>0.5	30000	PC	Ø280 * 62	10/0.056/12

# Ceiling Lights



Light source can be replaced

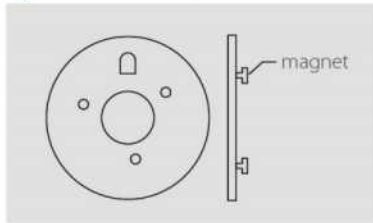

- Light source can be replaced
- Customized design
- Dial the code color
- IP20



Item No.	Voltage [V]	Wattage [W]	Lumen [lm]	Ra	PF	Life time [H]	Material	Size [DxHmm]	Packing [Pcs / M <sup>3</sup> / KG]
CE1003	185-265	12	840	≥80	>0.5	25000	PMMA+IRON	Ø260 * 90	16/0.139/8
CE1003	185-265	18	1170	≥80	>0.5	25000	PMMA+IRON	Ø330 * 95	10/0.138/7
CE1003	185-265	24	1560	≥80	>0.5	25000	PMMA+IRON	Ø380 * 100	10/0.203/10
CE1003	185-265	36	2360	≥80	>0.5	25000	PMMA+IRON	Ø480 * 105	5/0.286/16



# Ceiling Lights

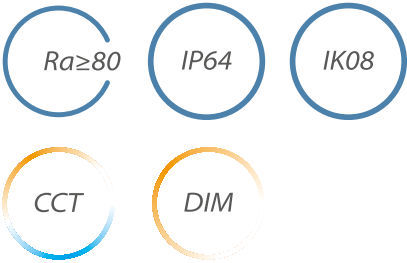

- Built-in Tuya intelligent module
- WIFI remote control
- Have dimmable, CCT adjustable function
- Support multi-scene choices and timing function

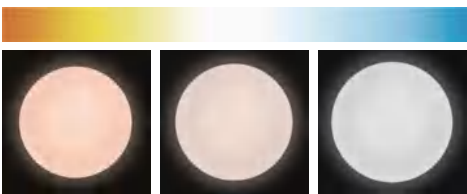

Item No.	Voltage [V]	Wattage [W]	Lumen [lm]	Ra	PF	Life time [H]	Material	Size [DxHmm]	Packing [Pcs / M³ / KG]
Smart-CE3030-WF2	185-265	18	1620	≥80	>0.5	25000	PC+PC	Ø280 * 60	10/0.063/9
Smart-CE3030-WF2	185-265	24	2160	≥80	>0.5	25000	PC+PC	Ø280 * 60	10/0.063/9
Smart-CE3030-WF2	185-265	30	2700	≥80	>0.9	25000	PC+PC	Ø330 * 60	8/0.070/9.2
Smart-CE3030-WF2	185-265	36	3240	≥80	>0.9	25000	PC+PC	Ø330 * 60	8/0.070/9.2



# Ceiling Lights

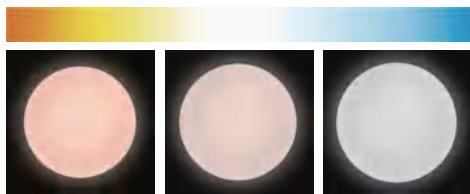

Item No.	Voltage [V]	Wattage [W]	Lumen [lm]	Ra	PF	Life time [H]	Material	Size [DxHmm]	Packing [Pcs / M <sup>3</sup> / KG]
CE2175/CE2175	185-265	12	1080	80	0.5	25000	PC+PC	Ø250 * 50	10/0.051/8
CE2175/CE2175	185-265	24	2160	80	0.5	25000	PC+PC	Ø320 * 50	10/0.072/9
CE2175/CE2175	185-265	40	3600	80	0.5/0.9	25000	PC+PC	Ø380 * 50	10/0.112/11

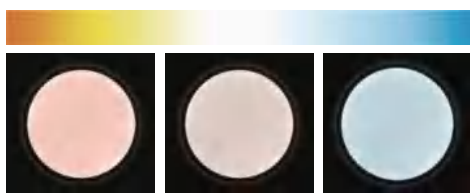

Item No.	Voltage [V]	Wattage [W]	Lumen [lm]	Ra	PF	Life time [H]	Material	Size [DxHmm]	Packing [Pcs / M <sup>3</sup> / KG]
CE2176/CE2176	175-240	18	1620	80	0.5	25 000	PC+PC	Ø300 * 30	10/0.051/8
CE2176/CE2176	175-240	24	2160	80	0.5	25 000	PC+PC	Ø420 * 30	10/0.097/9

# 10000LM



Adjust power

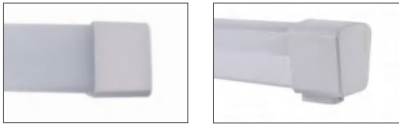

Height	Eavg	Emax	Angle	Diameter
3.281ft	31.63	114.8fc	12.90deg	9.895ft
1m	362.0	1236lx		301.59cm
6.562ft	8.408	28.71fc		19.79ft
2m	90.51	309.0lx		603.19cm
9.843ft	3.737	12.76fc		29.68ft
3m	40.23	137.3lx		904.78cm
13.12ft	2.102	7.17fc		39.58ft
4m	22.63	77.26lx		1206.38cm
16.4ft	1.345	4.59lx		49.47ft
5m	14.48	49.4lx		1507.97cm

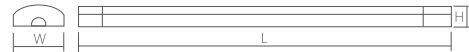
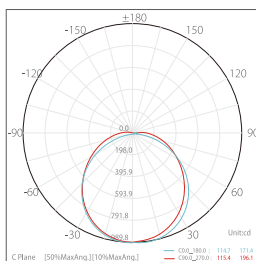





Item No.	Voltage [V]	Wattage [W]	Lumen [lm]	Ra	PF	Material	Lifetime [H]	Size [L*W*Hmm]	Packing [Pcs / M <sup>3</sup> / KG]
LU1093-36	120	36	3200	≥80	>0.9	PC	50000	1170*43*49	8 / 0.03 / 5
LU1093-42	120	42	4000	≥80	>0.9	PC	50000	1170*43*49	8 / 0.03 / 5
LU1093-52	120	52	5000	≥80	>0.9	PC	50000	1170*43*49	8 / 0.03 / 5

## 75mm Width



LU2006(Alu.)

LU2064(PC)

LU2006(Iron)



Three options for the cover:

Connectable & switch & non-connectable

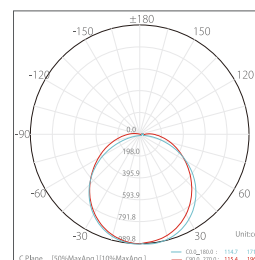
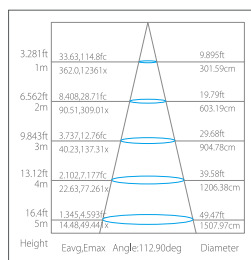

SMD2835



120°



ECO

Item No.	Voltage [V]	Wattage [W]	Lumen [lm]	Ra	PF	Material	Lifetime [H]	Size [L*W*Hmm]	Packing [Pcs / M <sup>3</sup> / KG]
LU2006-03-9	100-240	9	630	≥80	>0.9	Alu.+PP	20000	300*75*23	20 / 0.015 / 3.8
LU2006-05-18	100-240	18	1260	≥80	>0.9	Alu.+PP	20000	500*75*23	20 / 0.025 / 4.5
LU2006-06-18	100-240	18	1260	≥80	>0.9	Alu.+PP	20000	600*75*23	20 / 0.029 / 5
LU2006-10-36	100-240	36	2520	≥80	>0.9	Alu.+PP	20000	1000*75*23	20 / 0.047 / 5.8
LU2006-12-36	100-240	36	2520	≥80	>0.9	Alu.+PP	20000	1200*75*23	20 / 0.057 / 6.8
LU2006-15-45	100-240	45	3150	≥80	>0.9	Alu.+PP	20000	1500*75*23	20 / 0.007 / 8.5
LU2064-03-9	100-240	9	630	≥80	>0.9	PC+PP	20000	300*75*23	20 / 0.015 / 3.8
LU2064-05-18	100-240	18	1260	≥80	>0.9	PC+PP	20000	500*75*23	20 / 0.025 / 4.5
LU2064-06-18	100-240	18	1260	≥80	>0.9	PC+PP	20000	600*75*23	20 / 0.029 / 5
LU2064-10-36	100-240	36	2520	≥80	>0.9	PC+PP	20000	1000*75*23	20 / 0.047 / 5.8
LU2064-12-36	100-240	36	2520	≥80	>0.9	PC+PP	20000	1200*75*23	20 / 0.057 / 6.8
LU2064-15-45	100-240	45	3150	≥80	>0.9	PC+PP	20000	1500*75*23	20 / 0.007 / 8.5
LU2016-03-9	100-240	9	630	≥80	>0.9	Iron+PP	20000	300*75*23	20 / 0.015 / 3.8
LU2016-05-18	100-240	18	1260	≥80	>0.9	Iron+PP	20000	500*75*23	20 / 0.025 / 4.5
LU2016-06-18	100-240	18	1260	≥80	>0.9	Iron+PP	20000	600*75*23	20 / 0.029 / 5
LU2016-10-36	100-240	36	2520	≥80	>0.9	Iron+PP	20000	1000*75*23	20 / 0.047 / 5.8
LU2016-12-36	100-240	36	2520	≥80	>0.9	Iron+PP	20000	1200*75*23	20 / 0.057 / 6.8
LU2016-15-45	100-240	45	3150	≥80	>0.9	Iron+PP	20000	1500*75*23	20 / 0.007 / 8.5

# Lighting Fixtures NEW



Color Temp.  
adjustable



Emergency



## Details



## Emergency battery



## 3 CCT color adjustment

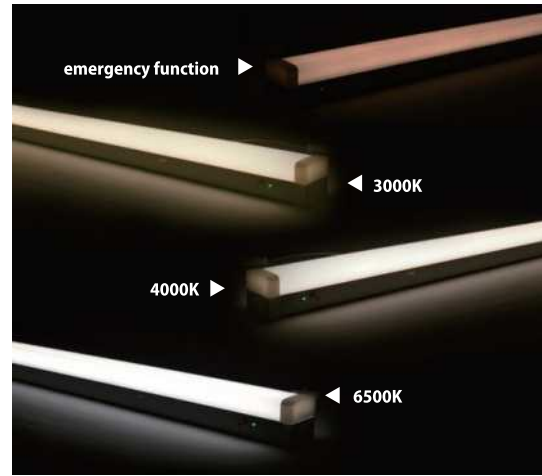

SMD2835



120°



ECO

Item No.	Voltage [V]	Wattage [W]	Lumen [lm]	Ra	PF	Material	Lifetime [H]	Size [L*W*Hmm]	Packing [Pcs / M <sup>3</sup> / KG]
LU2025/LU2029-20W	220-240	20	2400	≥80	>0.9	Iron+PC	30000	570*65*72	8 / 0.036 / 7.5
LU2025/LU2029-20W-CCT	220-240	20	2400	≥80	>0.9	Iron+PC	30000	570*65*72	8 / 0.036 / 7.5
LU2025/LU2029-40W	220-240	40	4800	≥80	>0.9	Iron+PC	30000	1170*65*72	8 / 0.071 / 13
LU2025/LU2029-40W-CCT	220-240	40	4800	≥80	>0.9	Iron+PC	30000	1170*65*72	8 / 0.071 / 13
LU2025/LU2029-40W-CCT-SY	220-240	60	7200	≥80	>0.9	Iron+PC	30000	1170*65*72	8 / 0.071 / 15.5
LU2025/LU2029-60W-CCT	220-240	60	7200	≥80	>0.9	Iron+PC	30000	1470*65*72	4 / 0.047 / 8.5
LU2025/LU2029-60W-CCT-SY	220-240	75	9000	≥80	>0.9	Iron+PC	30000	1470*65*72	4 / 0.047 / 9.5
LU2025/LU2029-75W-CCT	220-240	75	9000	≥80	>0.9	Iron+PC	30000	1770*65*72	4 / 0.056 / 10
LU2025/LU2029-75W-CCT-SY	220-240	75	9000	≥80	>0.9	Iron+PC	30000	1770*65*72	4 / 0.056 / 11

# Lighting Fixtures

## 80mm Width



Details

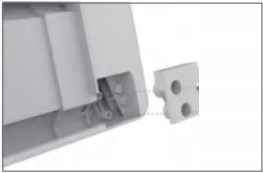

Back details



Installation diagram

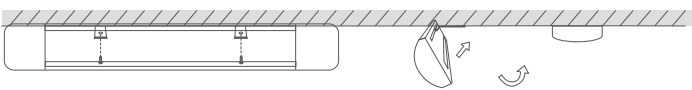

Application : Office, Basement, Supermarket, etc.

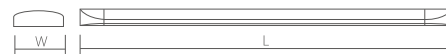
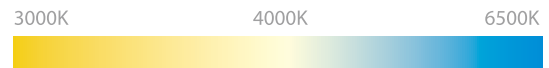

Item No.	Voltage [V]	Wattage [W]	Lumen [lm]	Ra	PF	Material	Lifetime [H]	Size [L*W*Hmm]	Packing [Pcs / M <sup>3</sup> / KG]
LU2026-06-20	220-240	20	2000	≥80	>0.9	Alu.+PC	30000	600*80*32	36 / 0.076 / 6.3
LU2026-12-40	220-240	40	4000	≥80	>0.9	Alu.+PC	30000	1200*80*32	10 / 0.149 / 11

# Lighting Fixtures



Color Temp.  
adjustable



Emergency



## Details

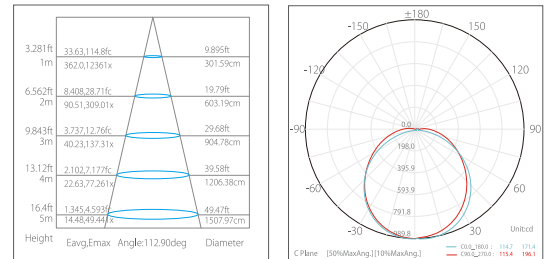

SMD2835



120°



ECO

Item No.	Voltage [V]	Wattage [W]	Lumen [lm]	Ra	PF	Material	Lifetime [H]	Size [L*W*H:mm]	Packing [Pcs / M <sup>3</sup> / KG]
LU2061-06-20	220-240	20	2000	≥80	>0.9	Alu.+PC	30000	600*80*48	20 / 0.038 / 15
LU2061-12-40	220-240	40	4000	≥80	>0.9	Alu.+PC	30000	1200*80*48	20 / 0.049 / 21
LU2061-15-60	220-240	60	6000	≥80	>0.9	Alu.+PC	30000	1500*80*48	20 / 0.049 / 21
LU2061-18-80	220-240	80	8000	≥80	>0.9	Alu.+PC	30000	1800*80*48	20 / 0.066 / 25



## Memory switch



Color Temp. adjustable



### Details



### Dialup dimming

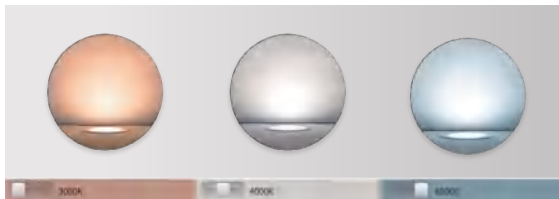
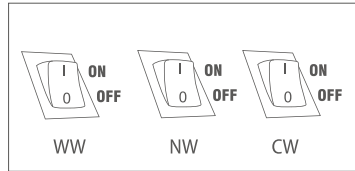

3000K 4000K 6500K

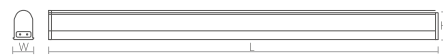
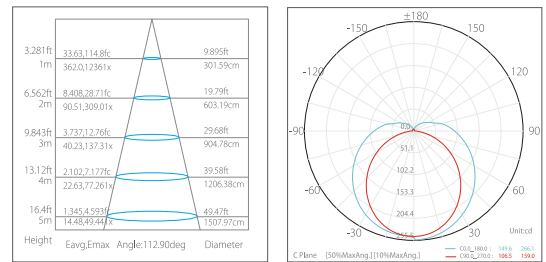

Item No.	Voltage [V]	Wattage [W]	Lumen [lm]	Ra	PF	Material	Lifetime [H]	Size [L*W*Hmm]	Packing [Pcs / M <sup>3</sup> / KG]
LU2039-03-4	220-240	4	400	≥80	>0.5	PC	30000	313*21*32	30/0.0314/4.8
LU2039-06-8	220-240	8	800	≥80	>0.5	PC	30000	573*21*32	30/0.0526/6.2
LU2039-09-13	220-240	13	1300	≥80	>0.5	PC	30000	873*21*32	30/0.0566/7.7
LU2039-12-18	220-240	18	1800	≥80	>0.5	PC	30000	1173*21*32	20/0.0754/9.1
LU2039-15-21	220-240	21	2100	≥80	>0.5	PC	30000	1473*21*32	20/0.0943/13
LU2039-1-03-4	220-240	4	400	≥80	>0.5	PC	30000	313*21*32	30/0.0314/4.8
LU2039-1-06-8	220-240	8	800	≥80	>0.5	PC	30000	573*21*32	30/0.0526/6.2
LU2039-1-09-13	220-240	13	1300	≥80	>0.5	PC	30000	873*21*32	30/0.0566/7.7
LU2039-1-12-18	220-240	18	1800	≥80	>0.5	PC	30000	1173*21*32	20/0.0754/9.1
LU2039-1-15-21	220-240	21	2100	≥80	>0.5	PC	30000	1473*21*32	20/0.0943/13

## Connection without shadow



### Accessories

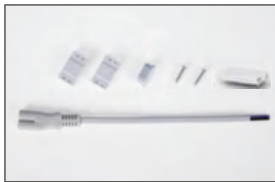

### Dialup dimming

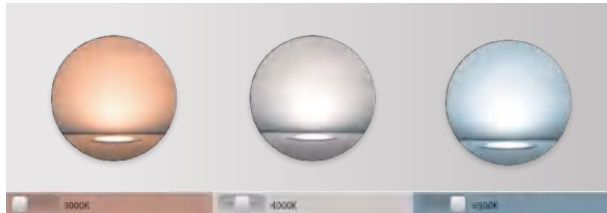
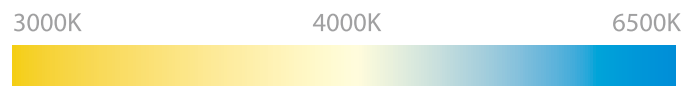
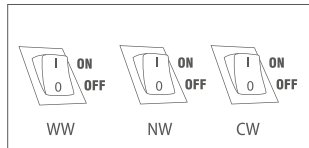

### Product link



### Connection without shadow

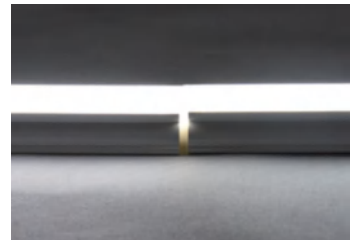

### Installation diagram

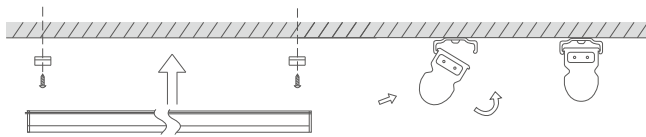

 **SMD2835**
 **120°**
 **ECO**

Item No.	Voltage [V]	Wattage [W]	Lumen [lm]	Ra	PF	Material	Lifetime [H]	Size [L*W*Hmm]	Packing [Pcs / M <sup>3</sup> / KG]
LU2027	100-240	4	320	≥80	>0.5	PC	30000	305*22*32	20 / 0.046 / 6
LU2027	100-240	8	640	≥80	>0.5	PC	30000	570*22*32	20 / 0.087 / 9.5
LU2027	100-240	12	960	≥80	>0.5	PC	30000	870*22*32	12 / 0.06 / 7
LU2027	100-240	16	1280	≥80	>0.5	PC	30000	1170*22*32	12 / 0.58 / 6

# Panel Lights



## Backlight



 **220-240V**
 **SMD2835**
 **30 000**
 **>0.9**
 **≥80**
 **120°**
 **ECO**

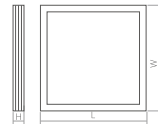

Item No.	Voltage [V]	Wattage [W]	Lumen [lm]	Material	Lifetime [H]	Size [L*W*Hmm]	Packing [Pcs/m <sup>2</sup> /KG]
PL2005-6060-36	220-240	36	3600	Iron	30000	595*595*24	10*0.141*18.0
PL2005-30120-36	220-240	36	3600	Iron	30000	295*1195*24	10*0.141*18.0
PL2005-6060-48	220-240	48	4800	Iron	30000	595*595*24	10*0.141*18.0
PL2005-30120-48	220-240	48	4800	Iron	30000	295*1195*24	10*0.141*18.0
PL2005-60120-72	220-240	72	7200	Iron	30000	595*1195*24	10*0.141*18.0

# Panel Lights



PL2002-D

PL2002-F

**120°**  
BEAM ANGLE

Diamond panel



Frosted panel



Details

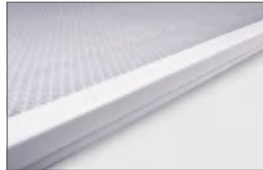

 **220-240V**
 **SMD2835**
 **30 000**
 **>0.9**
 **≥80**
 **120°**
 **ECO**

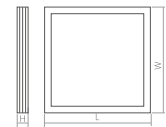

Item No.	Voltage [V]	Wattage [W]	Lumen [lm]	Material	Lifetime [H]	Size [L*W*Hmm]	Packing [Pcs/m <sup>2</sup> /KG]
PL2002-6060-24-D	220-240	24	2400	Iron	30000	595*595*19	4*0.036*6.6
PL2002-6060-24-F	220-240	24	2400	Iron	30000	595*595*19	4*0.036*6.6
PL2002-6060-36-D	220-240	36	2800	Iron	30000	595*595*19	4*0.036*6.6
PL2002-6060-36-F	220-240	36	2800	Iron	30000	595*595*19	4*0.036*6.6
PL2002-6060-45-D	220-240	45	4500	Iron	30000	595*595*19	4*0.036*6.6
PL2002-6060-45-F	220-240	45	4500	Iron	30000	595*595*19	4*0.036*6.6
PL2002-6060-72-D	220-240	72	5040	Iron	30000	595*595*19	4*0.036*6.6
PL2002-6060-72-F	220-240	72	5040	Iron	30000	595*595*19	4*0.036*6.6
PL2002-6060-96-D	220-240	96	10000	Iron	30000	595*595*19	4*0.036*6.6
PL2002-6060-96-F	220-240	96	10000	Iron	30000	595*595*19	4*0.036*6.6

**YUSING**

[www.yusinglighting.com](http://www.yusinglighting.com)

## **Ningbo Yusing Lighting Co,Ltd**

 **ADD:**No.1199Mingguang Road,jiangshan Town,Yingzhou,Ningbo China

 **TEL:**0574-83028340

 **E-mail:**sales79@yusinglighting.com